



P10iX

NITECORE®

XTREME PERFORMANCE

i-GENERATION 21700 ULTRA COMPACT FLASHLIGHT

 **4000** 4000 LUMENS

 **STROBE READY!** STROBE READY™
ULTIMATE ONE-HANDED OPERATION

 **USB-C RECHARGEABLE**

These images are for guide purpose only, actual result may vary depending on ambient factors.
They are the intellectual property of Nitecore. All rights to take legal action are reserved.

XTREME BREAKTHROUGH OF THE i-GENERATION

The groundbreaking i-Generation technology has brought infinite possibilities to the design of tactical flashlights. It is now unprecedentedly upgraded to enable a more reliable and rapid operation of tactics with an Xtreme performance.



P10iX 4000 Lumens



P10i 1800 Lumens



P10 V2 1100 Lumens



P10 800 Lumens



FUSION OF TACTICS AND TECHNOLOGY

- Utilizing 4 x CREE XP-L2 V6 LEDs with a max output of 4,000 lumens
- 2nd Generation STROBE READY™ Technology
- Powered by the optimized 21700 i Series Battery
- Compatible with i Series modular extensions
- Dual user modes available

NITECORE®

P10iX

XTREME PERFORMANCE

I-GENERATION 21700 ULTRA COMPACT FLASHLIGHT

4000 *Invincible Quad-Core Performance* **LUMENS MAX OUTPUT**

Utilizing 4 x CREE XP-L2 V6 LEDs, the P10iX has a max output of 4,000 lumens, a max throw of 158m and a peak beam intensity of 6,250cd, ideal for law enforcement, assault operations, self-defense, search and patrols.

Note: The stated data is measured in accordance with the international flashlight testing standard ANSI/PLATO FL 1-2019, using 1 x 21700 Li-Ion battery (5,000mAh) under laboratory conditions. The data may vary in real world use due to different battery usage or environmental conditions.

These images are for guide purpose only, actual result may vary depending on ambient factors.
They are the intellectual property of Nitecore. All rights to take legal action are reserved.

NITECORE®

P10iX

XTREME PERFORMANCE

I-GENERATION 21700 ULTRA COMPACT FLASHLIGHT

INDEPENDENTLY CONTROLLED QUADRUPLE LEDs

Powered by a constant current circuit to provide a durable usage with guaranteed safety.



These images are for guide purpose only, actual result may vary depending on ambient factors.
They are the intellectual property of Nitecore. All rights to take legal action are reserved.

2nd Generation (Patent No.: ZL201320545349.4)

STROBE READY™ TECHNOLOGY

Specially designed for tactical applications

- Enables a STROBE access in any state
- Inset pedal design to avoid accidental activation
(US Patent No.: 15/846299 US10237955B1)



ULTIMATE DUAL TAIL SWITCH DESIGN

Tactical Tail Switch

- Tactical Momentary-on
- Constant-on



STROBE READY™ Mode Button

- Output Adjustment
- Instantly Accessing STROBE / TURBO

DAILY MODE

Specially designed for daily uses and law enforcement with 6 brightness levels and memory function.

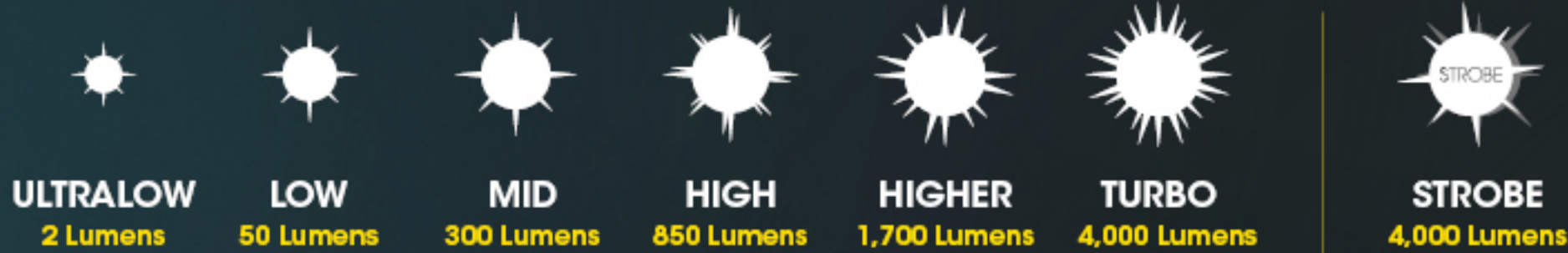

TWO USER MODES AVAILABLE

TACTICAL MODE

Specially designed for self defense and operations with 4 brightness levels and memorized instant access to TURBO / STROBE.



* The default setting is Daily Mode.
These images are for guide purpose only, actual result may vary depending on ambient factors.
They are the intellectual property of Nitecore. All rights to take legal action are reserved.

USB-C RECHARGEABLE

Available with a reversible plug-in

Note: DO NOT attempt to use the P10iX to charge CR123/RCR123 batteries.



CHARGING PORT COVER

Provides excellent water, dust and impact resistance

Positive
Negative



REVOLUTIONARY AND POWERFULLY UPGRADED 21700 *i* SERIES BATTERY

(Patent No. ZL201820118916.0, US Patent Pending)

- The 21700 i Series Battery is a patent product developed by NITECORE.
- Enables a highly efficient output by minimizing the loss of power due to internal resistance.
- Features dual way output with positive and negative polarities at both ends and a high energy density.
- Compatible with modular extensions of intelligent communications and controlling systems.



Positive

Negative

* The NL2150HPI rechargeable Li-Ion battery (5,000mAh) is included.

These images are for guide purpose only, actual result may vary depending on ambient factors.
They are the intellectual property of Nitecore. All rights to take legal action are reserved.

350 HOURS ULTRA LONG RUNTIME
CONSISTENT USAGE OF 14 DAYS ON ULTRALOW

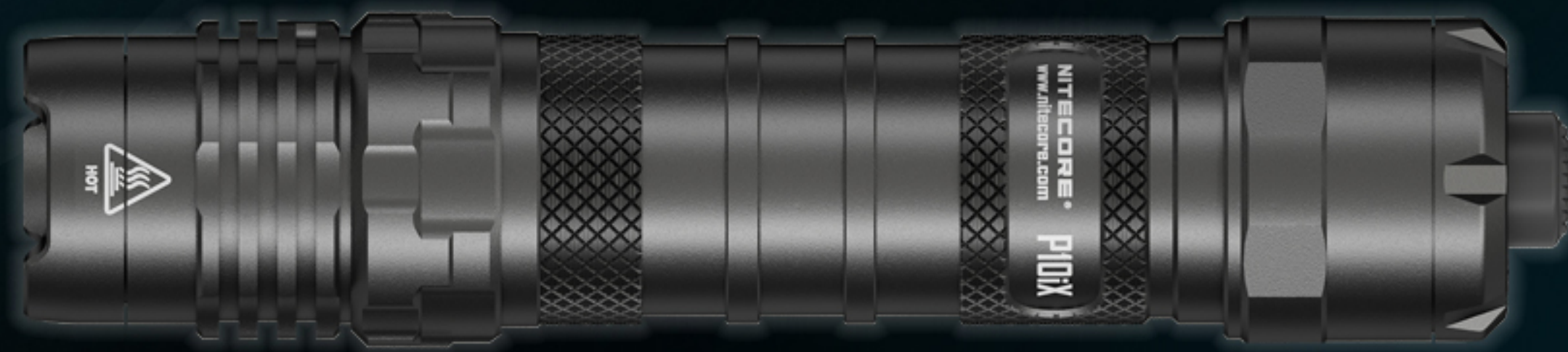

Note: The stated data is measured in accordance with the international flashlight testing standards ANSI/PLATO FL 1-2019, using 1 x 21700 Li-Ion battery (5,000mAh) under laboratory conditions. The data may vary in real world use due to different battery usage or environmental conditions.

These images are for guide purpose only, actual result may vary depending on ambient factors. They are the intellectual property of Nitecore. All rights to take legal action are reserved.

NITECORE®

P10iX **XTREME PERFORMANCE**
I-GENERATION 21700 ULTRA COMPACT FLASHLIGHT



MEMORY FUNCTION

When reactivated, the flashlight will automatically access the previous memorized brightness level or STROBE Mode.

Note: The Memory Function is only available in Daily Mode. It will only memorize TURBO or STROBE in Tactical Mode.

These images are for guide purpose only, actual result may vary depending on ambient factors. They are the intellectual property of Nitecore. All rights to take legal action are reserved.

**ATR**

ATR (Advanced Temperature Regulation)

(Patent No. ZL201510534543.6)

The integrated ATR technology regulates the output of the P10iX according to the working condition and ambient environment to maintain the optimal performance.

POWER INDICATOR

(Patent No. ZL201220057767.4)

When the battery is inserted, or the flashlight is disconnected from the power source during the charging process, the power indicator will flash to show the battery voltage ($\pm 0.1V$).



NITECORE®

P10iX **XTREME PERFORMANCE**
I-GENERATION 21700 ULTRA COMPACT FLASHLIGHT



ANTI-IMPACT REVERSE POLARITY PROTECTION MECHANISM

Specially Designed for Shooting Sports (Patent No.: ZL201220677948.7)

These images are for guide purpose only, actual result may vary depending on ambient factors.
They are the intellectual property of Nitecore. All rights to take legal action are reserved.

NITECORE®

P10iX XTREME PERFORMANCE
I-GENERATION 21700 ULTRA COMPACT FLASHLIGHT



ULTRA COMPACT AND LIGHTWEIGHT

With a Standard Tube Diameter of 1" (25.4mm)

- Length: 137.2mm (5.40")
- Head Diameter: 25.4mm (1")
- Tail Diameter: 28.5mm (1.12")
- Weight: 79.5g (2.80oz)



These images are for guide purpose only, actual result may vary depending on ambient factors.
They are the intellectual property of Nitecore. All rights to take legal action are reserved.

NITECORE®

FULL PACKAGE OF TACTICAL ACCESSORIES

P10iX **XTREME PERFORMANCE**
I-GENERATION 21700 ULTRA COMPACT FLASHLIGHT

INCLUDED



NL2150HPi
Battery 5,000mAh



CR123
Battery Magazine



NTH10
Tactical Holster



USB-C
Charging Cable



Lanyard



Clip



Spare O-ring



These images are for guide purpose only, actual result may vary depending on ambient factors.
They are the intellectual property of Nitecore. All rights to take legal action are reserved.

NITECORE®

P10iX XTREME PERFORMANCE
I-GENERATION 21700 ULTRA COMPACT FLASHLIGHT

NTH10 TACTICAL HOLSTER INCLUDED

Specially designed for law enforcement, the compact NTH10 Tactical Holster enables a quick draw of the flashlight with an adjustable stopper on the clip to suit belts of various sizes and compatible with the MOLLE System.

Compatible with belts of 1¼", 1½", 1¾", 2" and 2¼"



These images are for guide purpose only, actual result may vary depending on ambient factors.
They are the intellectual property of Nitecore. All rights to take legal action are reserved.

NITECORE®

P10iX

XTREME PERFORMANCE

I-GENERATION 21700 ULTRA COMPACT FLASHLIGHT



- Momentary On
- Output Adjustment

- Constant On/Off
- STROBE

Optional Accessories

RSW2i USB-C REMOTE SWITCH

Specially designed for i-Generation Flashlights, it has a USB-C port for charging or connecting the cable part of the remote switch.

These images are for guide purpose only, actual result may vary depending on ambient factors.
They are the intellectual property of Nitecore. All rights to take legal action are reserved.

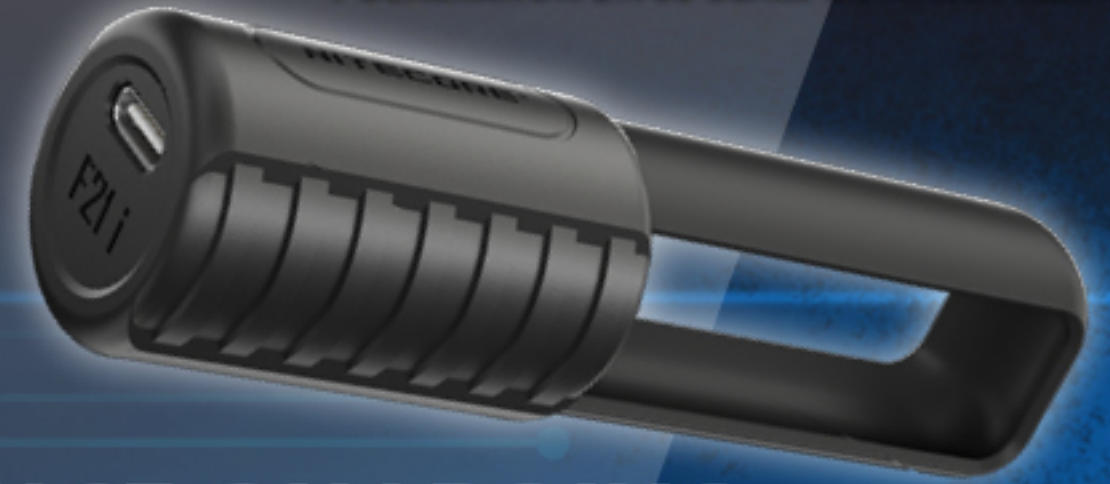

Optional Accessories

F21i FAST CHARGING POWER SYSTEM



Combined with a 21700 i Series Battery, it can be used as a battery charger or a power bank with a max power of 18W and protocols of QC 3.0 and PD. It is constructed from lightweight and fire retardant PC materials.

Technical Data

Input: USB-C: 5V=2A / 9V=2A

Output: USB-C: 5V=2.4A / 9V=2A / 12V=1.5A

SPECIALLY DESIGNED NEW SLOTS

COMPATIBLE WITH NTR10 TACTICAL RING PRO



- Keeps a two-handed grip of the firearm while carrying or operating a flashlight
- Easy for continuous and stable shooting and reloading

COMPATIBLE WITH POCKET CLIP



- Clipped in the pocket, the backpack or the MOLLE System
- Available for attaching the lanyard



NITECORE®

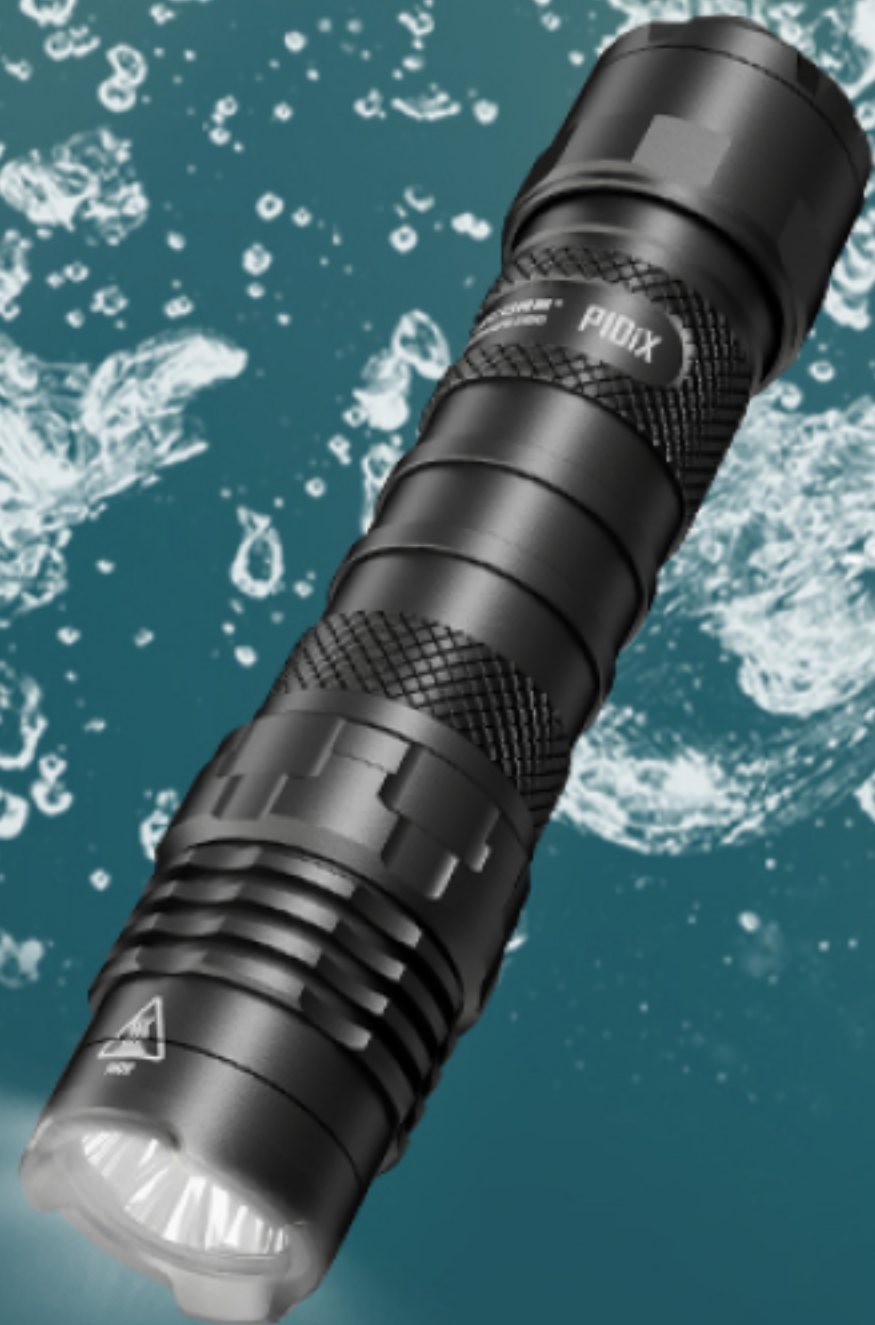

P10iX

XTREME PERFORMANCE

I-GENERATION 21700 ULTRA COMPACT FLASHLIGHT

ALL-WEATHER APPLICABLE

IP68 RATED 2m Submersible and Waterproof

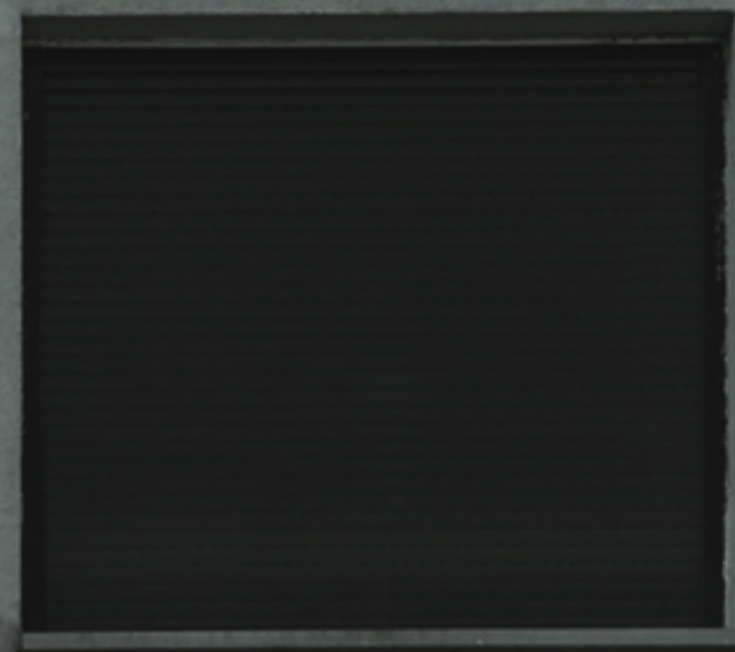

2m

UPGRADED RELIABILITY

2m Impact Resistant

1m

These images are for guide purpose only, actual result may vary depending on ambient factors.
They are the intellectual property of Nitecore. All rights to take legal action are reserved.

TECHNICAL DATA

Using a 5,000mAh 21700 Li-ion Battery:



FL1 STANDARD	TURBO	HIGHER	HIGH	MID	LOW	ULTRALOW	STROBE
	4,000 Lumens	1,700 Lumens	850 Lumens	300 Lumens	50 Lumens	2 Lumens	4,000 Lumens
	* 30min	2h	2h 30min	7h 15min	38h	350h	—
	158m	102m	72m	44m	17m	3m	—
	6,250cd	2,610cd	1,280cd	485cd	74cd	3cd	—
	2m (Impact Resistance)						
	IP68, 2m (Waterproof and Submersible)						

Note: The stated data is measured in accordance with the international flashlight testing standard ANSI/PLATO FL 1-2019, using 1 x 21700 Li-ion battery (5,000mAh) under laboratory conditions. The data may vary in real world use due to different battery usage or environmental conditions.
 * The runtime of TURBO is tested without the temperature regulation.

Using 2 x CR123 Batteries:

FL1 STANDARD	HIGH	MID	LOW	ULTRALOW	STROBE
	1,060 Lumens	300 Lumens	50 Lumens	2 Lumens	1,060 Lumens
	1h	3h 30min	14h	120h	—
	80m	44m	17m	3m	—
	1,620cd	485cd	74cd	3cd	—
	2m (Impact Resistance)				
	IP68, 2m (Waterproof and Submersible)				

Note: The stated data is measured in accordance with the international flashlight testing standard ANSI/PLATO FL 1-2019, using 2 x CR123 lithium batteries (1,700mAh) under laboratory conditions. The data may vary in real world use due to different battery usage or environmental conditions.

FEATURES

- Utilizes 4 x CREE XP-L2 V6 LEDs with a max output of 4,000 lumens
- An optical system combined with crystal coating and "Precision Digital Optics Technology" (PDOT)
- Max peak beam intensity of 6,250cd and max throw of 158 meters
- Highly efficient constant current circuit provides a stable output for up to 350 hours
- Dual tail switches enable intuitive operations for tactical applications
- STROBE READY™ Technology to enable a quick access to STROBE Mode (Patent No. ZL201320545349.4)
- STROBE Mode uses randomly changing frequencies for stronger dizzying effects
- Tactical Mode and Daily Mode available
- Intelligent Li-ion battery charging circuit with a USB-C port
- NITECORE 21700 Li-ion battery included (NL2150HPi 5,000mAh)
- A power indicator beside the charging port indicates the remaining battery power (Patent No. ZL201220057767.4)
- The power indicator can display the battery voltage ($\pm 0.1V$)
- Incorporated Advanced Temperature Regulation (ATR) module (Patent No. ZL201510534543.6)
- Optical lenses with double-sided scratch resistant coating
- Constructed from aero grade aluminum alloy
- HA III military grade hard-anodized finish
- Waterproof and dustproof rating in accordance with IP68 (2 meters submersible)
- Impact resistant to 2 meters



NITECORE®

CUSTOMIZABLE TACTICAL ACCESSORIES

P10iX

XTREME PERFORMANCE

I-GENERATION 21700 ULTRA COMPACT FLASHLIGHT

OPTIONAL

Diffuser



NDF25

Traffic Wand



NTW25

NTR10



Tactical Ring Pro

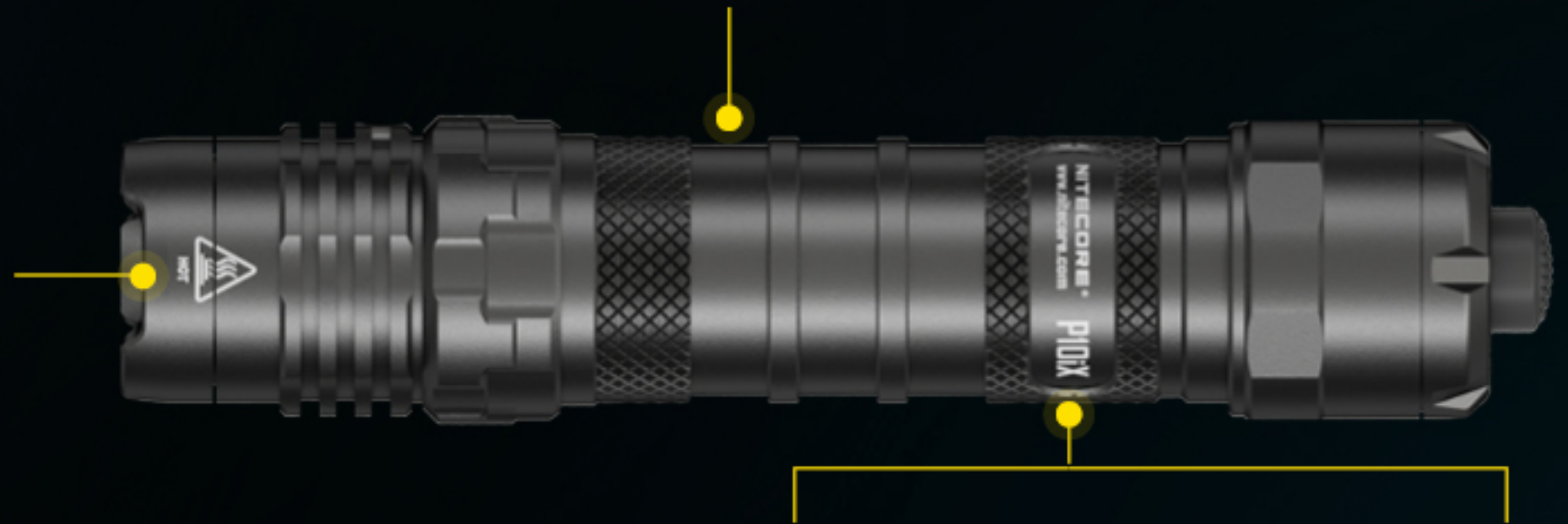

NITECORE Gun Mounts

Helmet Mount



GM02MH



GM03



GM04



LMA1

These images are for guide purpose only, actual result may vary depending on ambient factors. They are the intellectual property of Nitecore. All rights to take legal action are reserved.